



Lindab **FKD**

Multi-cone diffuser



Multi-cone diffuser

FKD



Description

FKD is an adjustable circular multi-cone diffuser, which is typically used for supply air. The diffuser can be switched between horizontal and vertical supply air and is therefore ideal for the supply of both heated and cooled air. Installing an FKD diffuser up to size 400 in a plenum box type MB can help to achieve a stable airflow to the diffuser as well as realise the potential for individual adjustment. Damper type B is an unique linear cone damper which allows to use the full operational area (0-100%) and allows to balance with a high pressure drop over the box with low sound generation. Furthermore the construction of the damper gives an accurate and reliable measurement. Damper type C has a rotating blade damper for supply air. Typically used in applications that don't require a high balancing pressure in the plenum box.

- Suitable for supply air
- Vertical or horizontal supply air pattern
- Plenum box with several damper options
- On request available in stainless steel AISI 304 or 316

Maintenance

The multi-cone insert can be removed to enable cleaning of internal parts or to gain access to the duct or box. The visible parts of the diffuser can be wiped with a damp cloth.

Order code

Product	FKD - aaa
Type	FKD
Connection dim.	Ø160-630

Example: FKD-200

Dimensions

Vertical

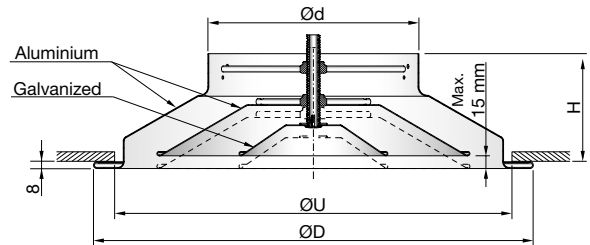

Horizontal

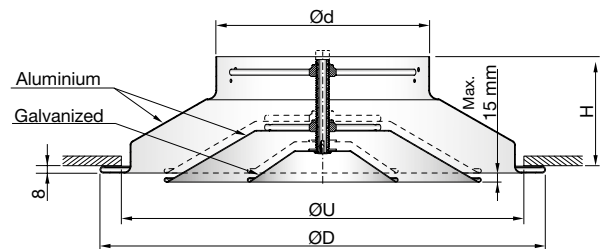

FKD	Free area A						
	Ød	ØD	H	ØU*	Vertical	Horizontal	m
	mm	mm	mm	mm	m ²	m ²	kg
160	335	335	97	288	0.0298	0.0304	0.7
200	423	423	110	370	0.0431	0.0456	0.9
250	517	517	122	461	0.0622	0.0684	1.2
315	640	640	138	576	0.091	0.1041	1.8
355	730	730	177	656	0.1108	0.1293	2.6
400	776	776	177	700	0.1349	0.1606	3.1
450	825	825	177	755	0.1637	0.199	3.4
500	917	917	177	825	0.1948	0.241	4.3
630	1045	1045	177	963	0.285	0.3667	7.4

ØU* = Cutting dimension

Number of cones: size 160-355 : 2
size 400-500 : 3
size 630 : 4

Materials and finish

Material: Aluminium + galvanized steel.
Standard finish: Powder-coated
Standard colours: RAL 9003 or RAL 9010, gloss 30

The diffuser is available in other colours or unpainted. On request also available in stainless steel AISI 304 or 316. Please contact Lindab's sales department for further information.

Multi-cone diffuser

FKD

Dispersal patterns

FKD is supplied for vertical supply air as standard. The dispersal pattern can be altered to horizontal supply air by setting the inner part of the diffuser to its lowest position.

Horizontal

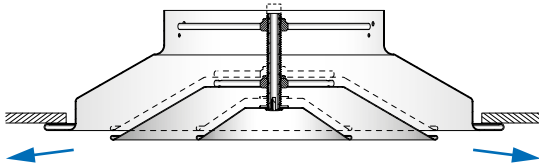

Vertical

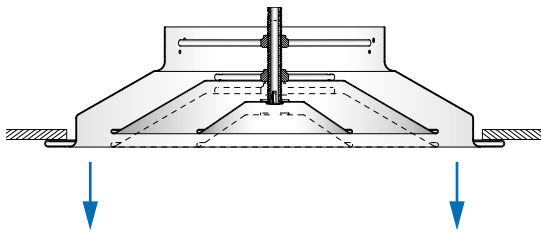

Important!

The straight duct must have the correct length to secure a stable faceplate.

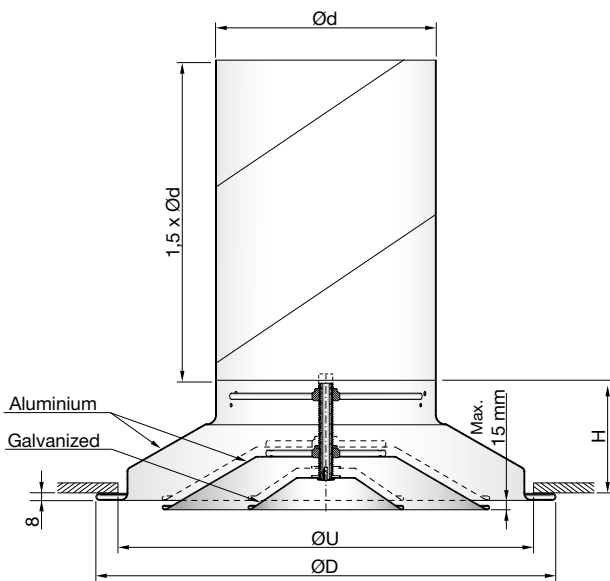

Accessories

FKD + MB Plenum box

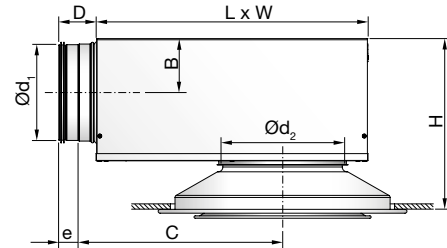

$\varnothing d_1$ mm	$\varnothing d_2$ mm	B	C	D	e	H*	L	W
100	160	62	245	78	40	221 - 243	310	260
125	160	75	291	78	40	246 - 268	376	310
125	200	75	291	78	40	257 - 281	376	310
160	160	92	352	78	40	280 - 302	459	380
160	200	92	352	78	40	291 - 315	459	380
160	250	92	352	78	40	305 - 327	459	380
200	200	112	425	78	40	332 - 356	565	460
200	250	112	425	78	40	346 - 368	565	460
200	315	112	425	78	40	363 - 384	565	460
250	250	137	514	118	60	396 - 418	698	540
250	315	137	514	118	60	413 - 434	698	540
250	400	137	514	118	60	440 - 473	698	540
315	315	170	675	118	60	478 - 499	858	540
315	400	170	675	118	60	505 - 538	858	540

Damper options

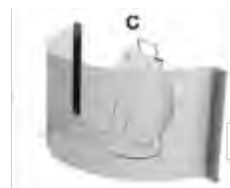

Order code

Product	MB	a	bbb	ccc	S
Type					
MB					
Damper					
B = Linear cone damper					
C = Blade damper supply					
Duct connection $\varnothing d_1$					
$\varnothing 100-315$					
Diffuser dimension $\varnothing d_2$					
$\varnothing 160-400$					
Function (Only for B damper)					
S = Supply air					

Example 1: FKD-200+MBB-160-200-S
 Example 2: FKD-200+MBC-160-200

Multi-cone diffuser

FKD

Technical data

Following FKD+plenum box data are valid for MBB-S. For MBC data, go to www.lindQST.com.

Capacity

Volume flow q_v [l/s] and [m³/h], total pressure Δp_t [Pa], throw $l_{0.2}$ [m] and sound power level L_{WA} [dB(A)] can be seen in the diagrams.

Throw $l_{0.2}$

Throw $l_{0.2}$ [m] can be seen in the diagram for isothermal air at a speed of 0.2 m/s.

Frequency-related sound effect level

The sound power level in the frequency band is defined as $L_{w_{ok}} = L_{WA} + K_{ok}$. K_{ok} values are specified in charts beneath the diagrams on the following pages. K_{ok} values for FKD without a box can be found in a separate supplement.

Sound attenuation

Sound attenuation of the diffusers ΔL from duct to room, including end reflection, see table below.

FKD + MBB-S		Centre frequency Hz								
duct	FKD	63	125	250	500	1K	2K	4K	8K	
$\varnothing d_1$	$\varnothing d_2$									
100	160	20	16	5	15	17	17	16	19	
125	160	13	13	8	19	13	16	16	19	
125	200	15	11	6	15	12	14	16	17	
160	160	16	17	10	18	17	18	20	21	
160	200	15	14	7	19	15	16	18	19	
160	250	17	16	4	16	15	16	16	18	
200	200	13	10	6	15	18	15	19	17	
200	250	13	9	4	12	17	13	17	16	
200	315	13	8	3	8	16	14	16	15	
250	250	14	8	8	15	17	17	17	18	
250	315	13	6	5	13	15	15	16	17	
250	400	12	4	3	12	13	14	14	15	
315	315	7	9	8	12	17	16	17	21	
315	400	7	8	7	11	16	14	16	19	

Balancing

Balancing data is contained in a separate brochure.

Horizontal

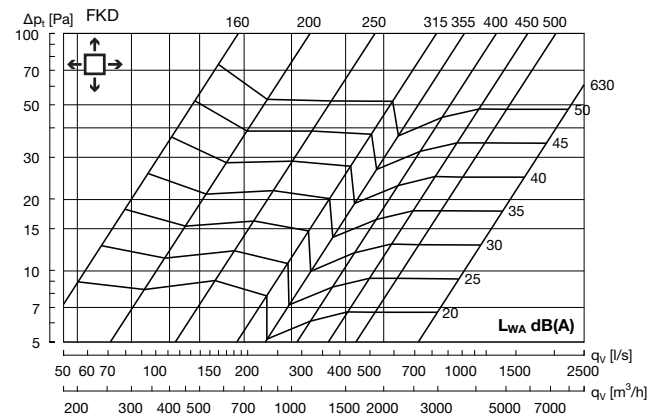
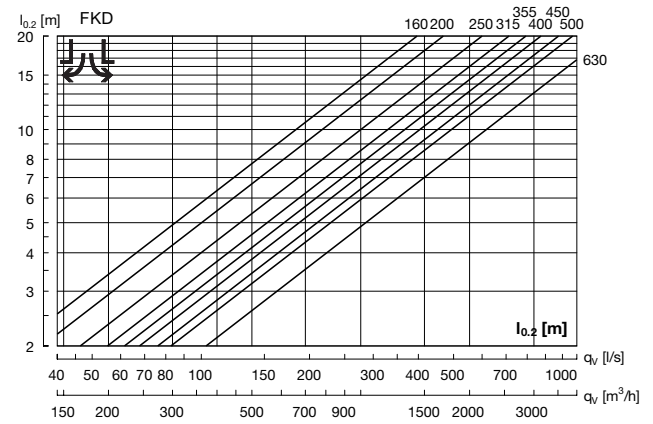

Multi-cone diffuser

FKD

Technical data

Throw $l_{0,2}$ / turning point $l_{0,0}$

Throws $l_{0,2}$ [m] can be seen in the diagrams for isothermal air at a speed of 0.2 m/s. Turning point $l_{0,0}$ [m] can be seen in the diagrams for heated air, +5 K, +10 K respectively.

Vertical

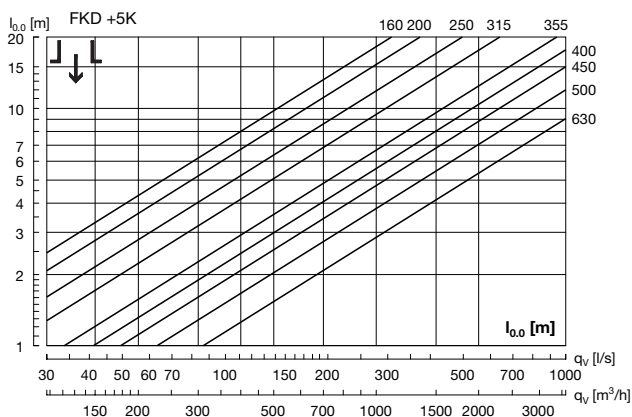
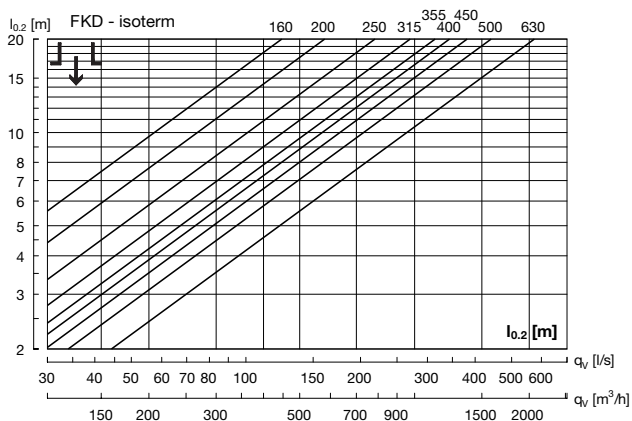
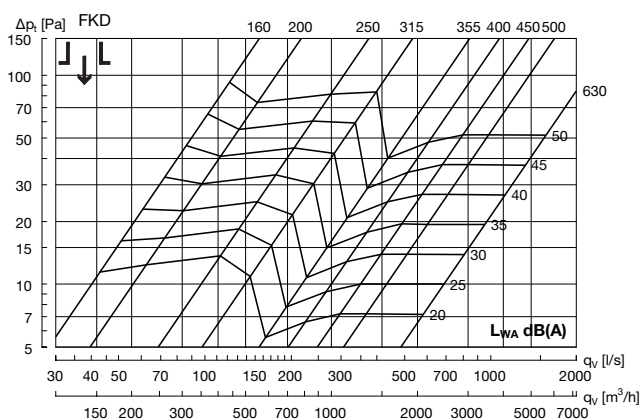

Vertical supply air correction sound power level (L_{WA}) and pressure loss (Δp_t)

On the following pages you can find diagrams for all sizes FKD+MBB-S horizontal supply air. When Vertical supply air values are wanted, use the correction factors in the table below.

FKD + MBB-S		Vertical supply air Correction factor	
duct $\varnothing d_1$	FKD $\varnothing d_2$	L_{WA}	Δp_t
100	160	3	x 1,2
125	160	1	x 1,2
125	200	1	x 1,1
160	160	5	x 1,5
160	200	3	x 1,3
160	250	0	x 1,1
200	200	1	x 1,3
200	250	5	x 1,2
200	315	0	x 1,1
250	250	1	x 1,3
250	315	2	x 1,3
250	400	1	x 1,1
315	315	4	x 1,4
315	400	3	x 1,2

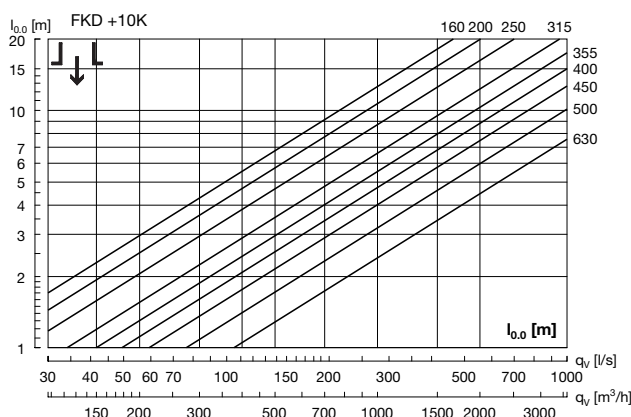

Multi-cone diffuser

FKD

Technical data

FKD 160 + MBB-S Horizontal

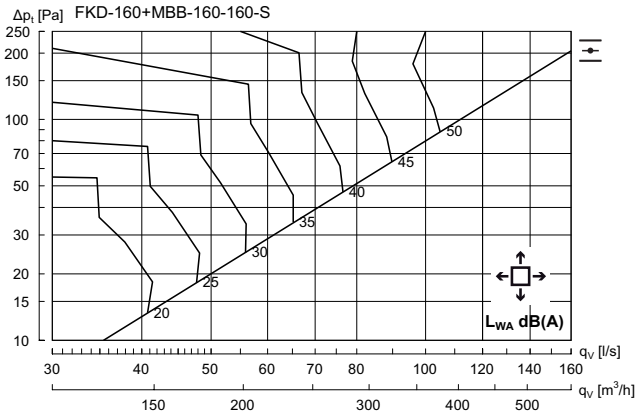

Hz	63	125	250	500	1K	2K	4K	8K
K_{sk}	11	7	0	-6	-4	-9	-22	-31

FKD 200 + MBB-S Horizontal

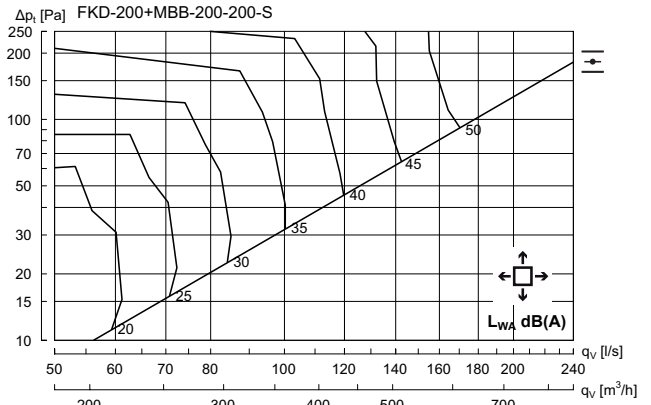

Hz	63	125	250	500	1K	2K	4K	8K
K_{sk}	13	5	-2	-5	-3	-12	-22	-28

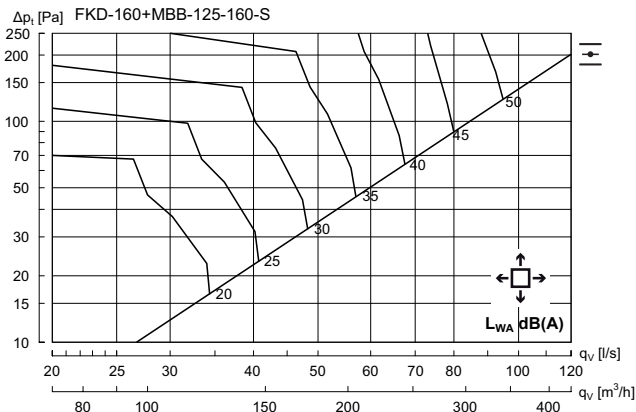

Hz	63	125	250	500	1K	2K	4K	8K
K_{sk}	10	5	2	-5	-5	-9	-18	-25

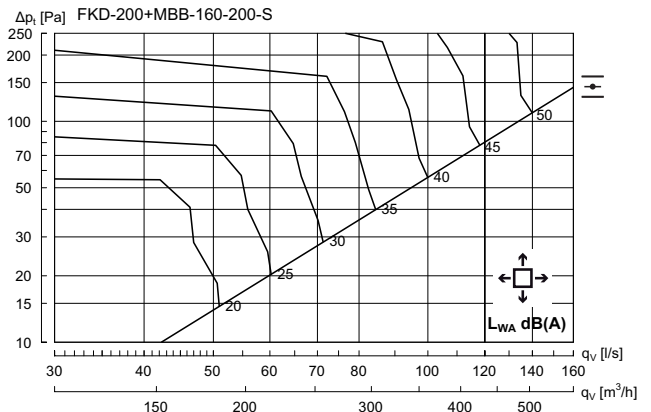

Hz	63	125	250	500	1K	2K	4K	8K
K_{sk}	11	5	1	-5	-4	-11	-20	-25

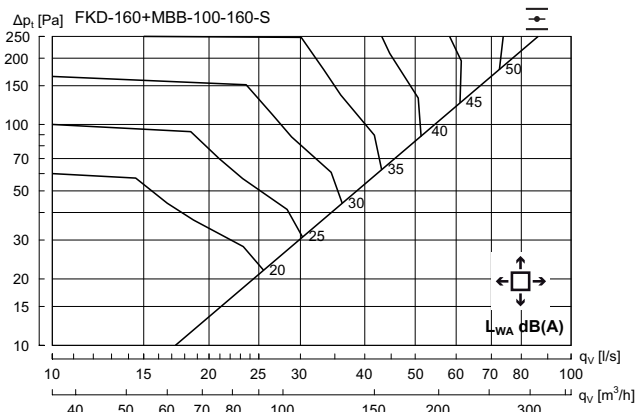

Hz	63	125	250	500	1K	2K	4K	8K
K_{sk}	9	4	2	-3	-5	-9	-16	-22

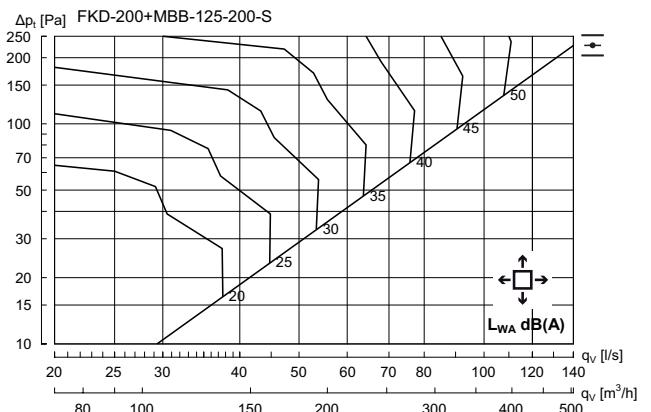

Hz	63	125	250	500	1K	2K	4K	8K
K_{sk}	11	4	1	-4	-4	-10	-16	-23

Multi-cone diffuser

FKD

Technical data

FKD 250 + MBB-S Horizontal

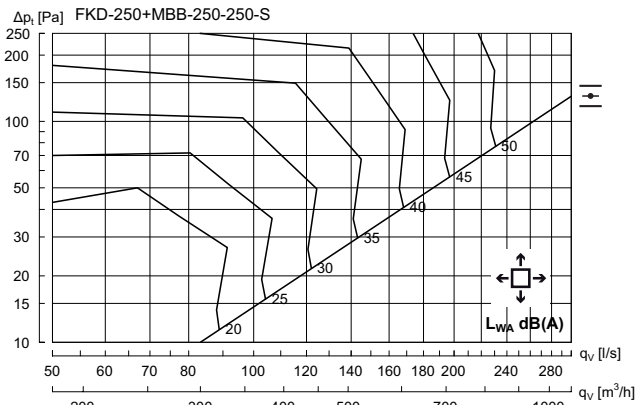

Hz	63	125	250	500	1K	2K	4K	8K
K_{ok}	12	5	-2	-4	-3	-13	-20	-26

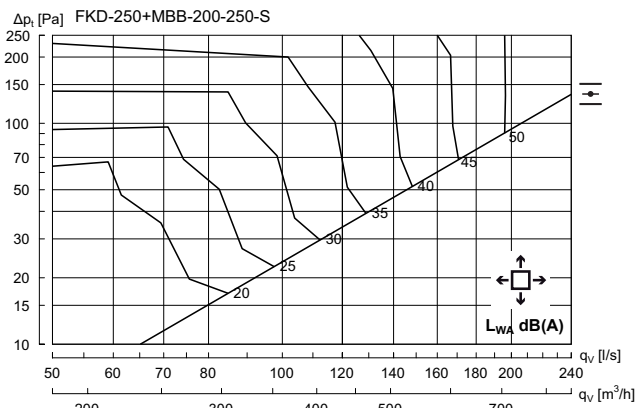

Hz	63	125	250	500	1K	2K	4K	8K
K_{ok}	11	5	-2	-3	-3	-12	-19	-24

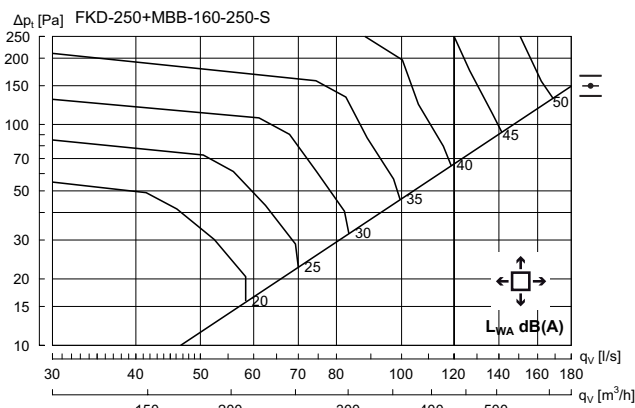

Hz	63	125	250	500	1K	2K	4K	8K
K_{ok}	12	4	0	-3	-4	-12	-18	-24

FKD 315 + MBB-S Horizontal

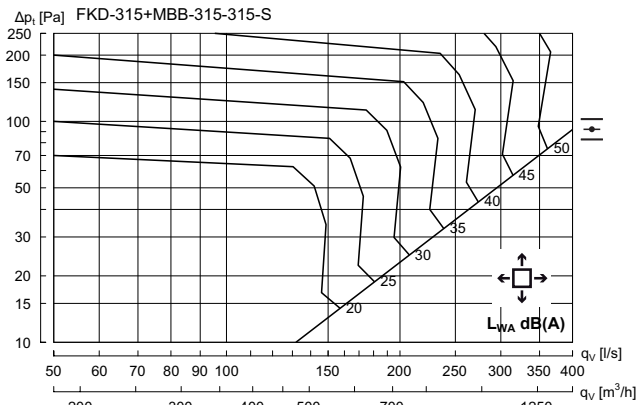

Hz	63	125	250	500	1K	2K	4K	8K
K_{ok}	14	3	0	-2	-4	-14	-20	-26

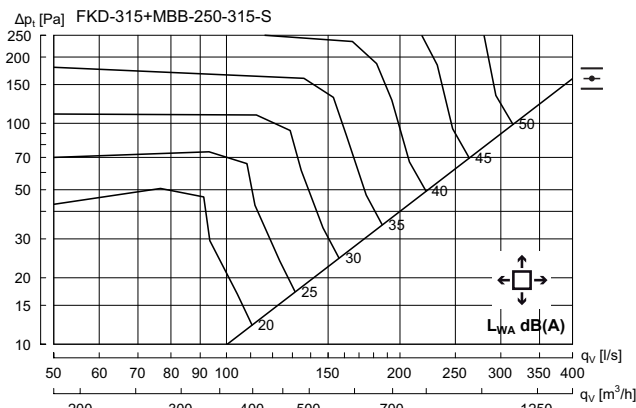

Hz	63	125	250	500	1K	2K	4K	8K
K_{ok}	12	5	-1	-2	-4	-12	-19	-21

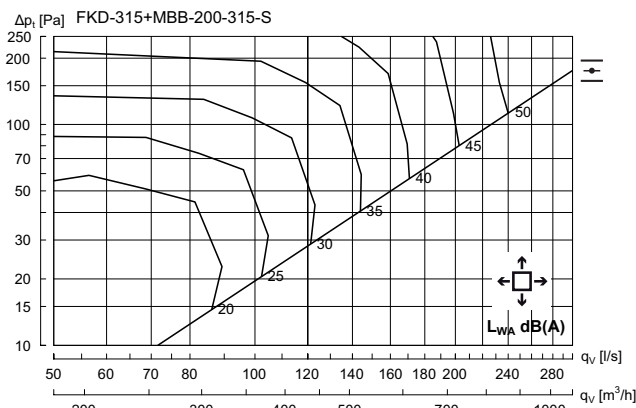

Hz	63	125	250	500	1K	2K	4K	8K
K_{ok}	9	5	-1	-2	-5	-11	-18	-24

Multi-cone diffuser

FKD

Technical data

FKD 400 + MBB-S Horizontal

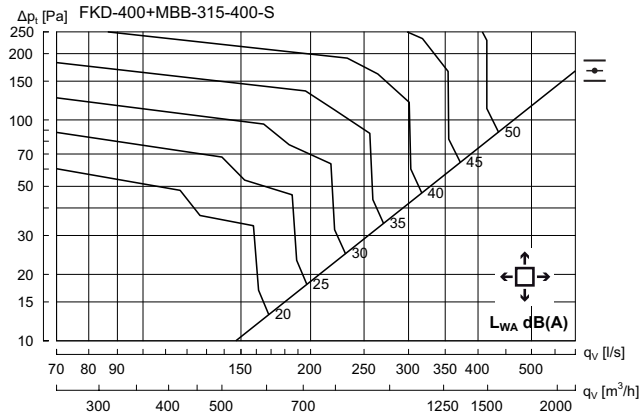

Hz	63	125	250	500	1K	2K	4K	8K
K_{sk}	11	4	1	-1	-6	-12	-17	-24

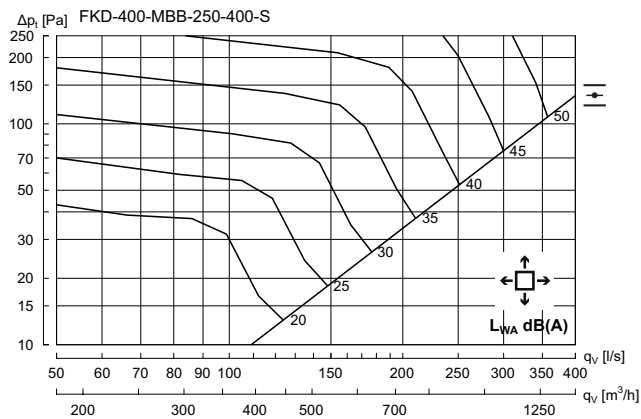

Hz	63	125	250	500	1K	2K	4K	8K
K_{sk}	9	4	1	-1	-6	-12	-17	-25



Most of us spend the majority of our time indoors. Indoor climate is crucial to how we feel, how productive we are and if we stay healthy.

We at Lindab have therefore made it our most important objective to contribute to an indoor climate that improves people's lives. We do this by developing energy-efficient ventilation solutions and durable building products. We also aim to contribute to a better climate for our planet by working in a way that is sustainable for both people and the environment.

[Lindab | For a better climate](#)