

RGS

Circular duct grille



Circular duct grille

RGS

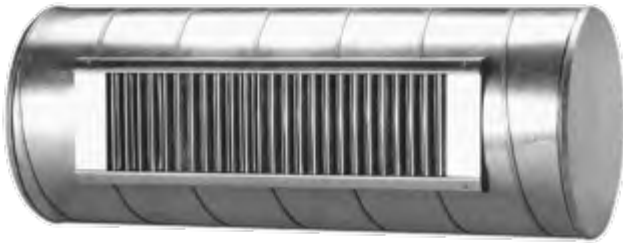

Description

RGS is a rectangular ventilation grille with vertical adjustable bars for direct installation in circular ducts. The grille can be used for both supply and extract air. The grille can be supplied with horizontal directional bars, straight or slanting sliding damper or blade damper. The grille is designed so that the grille flanges always fit tight to the duct regardless of the duct diameter. RGS is made of galvanised steel plate and is put together without welding. This means that the grille can be used without further surface treatment. The exterior of the grille thus matches the duct surface.

- Can be used for both supply and extract air
- Installed directly in circular duct
- Can be fitted with many types of accessory
- Tested according to EN 1366-9 and EN 1366-8
- CE certified to EN 12101-7

Maintenance

The grille should be removed to gain access to the duct.

Order code

Product	RGS	a	bbb	ccc
Type				
Accessories				
A - measure				
B - measure				

A x B = Cutting dimension

Dimensions

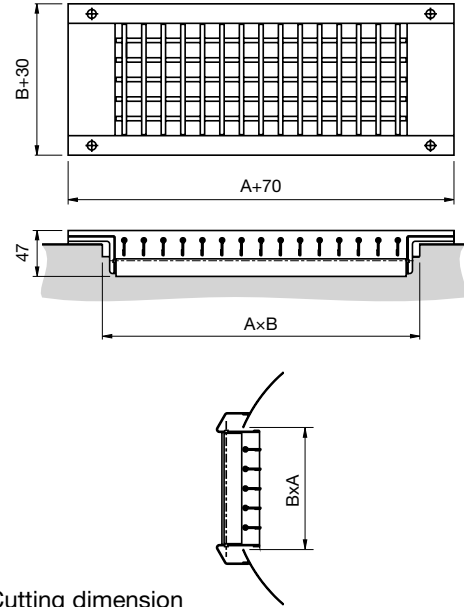

A x B = Cutting dimension

Screws included.

Installation

Correct installation of RGS gratings in relation to the direction of the air in the duct:

RGS-2, 3:

Supply air:



Extract system:

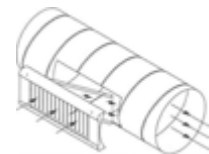

RGS-6,7:

Supply air:

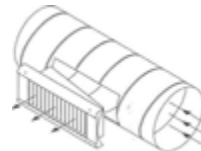

Extract system:

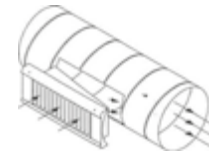

Materials and finish

Grille:	Galvanised steel
Sliding damper:	Electro-galvanised steel
Blade damper:	Electro-galvanised steel

The diffuser is available in other colours. Please contact Lindab's sales department for further information.

Circular duct grille

RGS

Dimensions

Measure mm	Min duct measure Ø mm	Free area F m ²	C- Measure mm	RGS 1 Weight kg
325 x 75	160	0.017	106	1.10
325 x 125	250	0.028	106	1.30
325 x 150	315	0.034	106	1.40
325 x 225	500	0.056	106	2.20
425 x 75	160	0.023	116	1.40
425 x 125	250	0.037	116	1.80
425 x 150	315	0.045	116	1.90
425 x 225	500	0.074	116	3.00
525 x 75	160	0.028	126	1.70
525 x 125	250	0.047	126	2.00
525 x 150	315	0.056	126	2.30
525 x 225	500	0.093	126	3.40
625 x 75	160	0.034	131	1.90
625 x 125	250	0.056	131	2.40
625 x 150	315	0.068	131	2.60
625 x 225	500	0.112	131	3.70
825 x 75	160	0.045	151	2.40
825 x 125	250	0.074	151	3.10
825 x 150	315	0.093	151	3.50
825 x 225	500	0.148	151	5.10
1025 x 75	200	0.056	166	2.90
1025 x 125	250	0.093	166	3.40
1025 x 150	315	0.112	166	3.90
1025 x 225	500	0.168	166	5.80
1225 x 75	200	0.068	186	3.20
1225 x 125	250	0.112	186	4.00
1225 x 150	315	0.136	186	4.40
1225 x 225	500	0.224	186	6.30

Use

RGS-2

Suitable for supply and extract air. The grille is equipped with a single adjustment damper and has a lower sound level than RGS-6.

RGS-3

As RGS-2 with horizontal directional bars specifically for supply air.

RGS-4

The grille is suitable for extract only.

RGS-6 Slanting sliding damper

Suitable for supply and extract air. The grille is equipped with a slanting sliding damper, which means the air is distributed evenly over the whole grille.

RGS-7

As RGS-6 with horizontal directional bars specifically for supply air.

Accessories

RGS-0, without accessories.



RGS-1, With directional bars.



RGS-2, With blade damper.

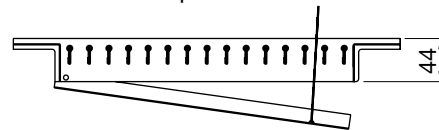

RGS-3, With directional bars and blade damper.

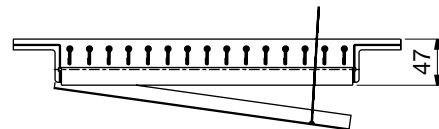

RGS-4, With straight sliding damper.

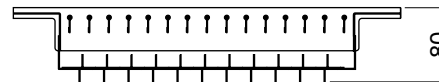

RGS-6, With slanting sliding damper.

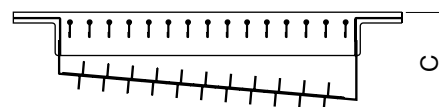

RGS-7, With directional bars and slanting sliding damper.

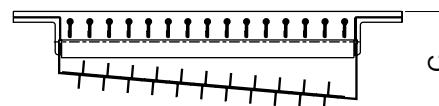

Circular duct grille

RGS

Technical data

Effective speed v_0

The diagram for throw (see next page) specifies effective speed v_0 [m/s] as a function of the volume flow q [m³/h, l/s] for each grille size with 0° bar setting.

Throw $l_{0,2}$

The diagram for throw (see next page) specifies the throw $l_{0,2}$ [m] at an average terminal velocity of 0.2 m/s, 0° bar setting without ceiling effect. (Distance from grille to ceiling greater than 800 mm.)

Table 1: Correction for dispersal.

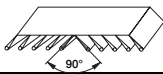
Bar setting		
Correction factor V_0	1,1	1,2
Correction factor $l_{0,2}$	0,8	0,5

Ceiling effect

If the distance from grille to ceiling is less than 300 mm, the throw $l_{0,2}$ must be multiplied by 1.4.

Total pressure p_t

The diagram "Pressure – sound level" states the grille's total pressure p_t [Pa].

Sound effect level L_{WA}

The diagram "Pressure – sound level" states the grille's sound effect level L_{WA} [dB(A)] at a free area of 0.05 m².

Table 2: Correction for free area.

Correction free area	
F [m ²]	0,02 0,025 0,03 0,04 0,05 0,06 0,08 0,1 0,13 0,17 0,2
correction [dB]	-4 -3 -2 -1 0 +1 +2 +3 +4 +5 +6

Duct speed v_k

Pressure and sound effect level are stated for different duct speeds v_k [m/s].

For duct speeds $v_k < 1$ m/s, the sound values L_{WA} must be corrected by -7 dB.

The diagrams on the following pages are in table form. See dimensioning tables.

The values apply to grilles with 0° dispersal.

Table 3: Correction for dispersal.

Bar setting	45°	90°
Pressure	x1,15	x1,3
Sound power level	+1	+2

Air jet dispersal

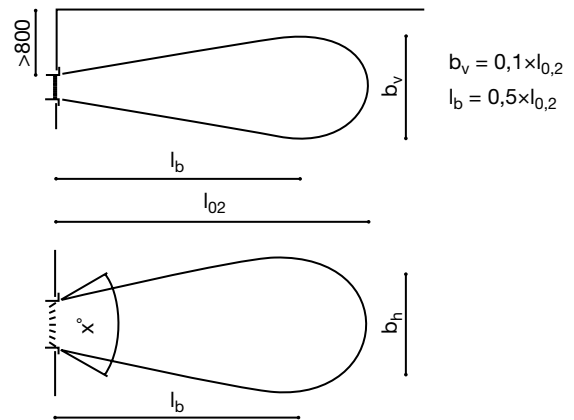

$$b_v = 0,1 \times l_{0,2}$$

$$l_b = 0,5 \times l_{0,2}$$

$$X = 0^\circ : b_h = 0,3 \times l_{0,2} \quad l_b = 0,5 \times l_{0,2}$$

$$X = 45^\circ : b_h = 0,4 \times l_{0,2} \quad l_b = 0,5 \times l_{0,2}$$

$$X = 90^\circ : b_h = 0,6 \times l_{0,2} \quad l_b = 0,5 \times l_{0,2}$$

$l_{0,2}$: Catalogue values

Sample calculation 1

Room width: $W = 6$ m,
 Room height: $H = 2.6$ m
 Volume flow per grille: 300 m³/h
 Duct speed: $v_k = 4$ m/s
 Speed in the occupied zone: < 0.25 m/s

From next page:

$$v_x = \frac{l_{0,2}}{B + C} \times 0,2 \quad C = H - 1,8 = 0,8 \text{ m}$$

$$v_x = \leq 0,25 \text{ m/s} \quad B + C = 6,8 \text{ m}$$

$$l_{0,2} \leq (B + C) \times \frac{v_x}{0,2} \leq 6,8 \times \frac{0,25}{0,2} \leq 8,5 \text{ m}$$

The diagram "Effective speed v_0 - Throw $l_{0,2}$ " (next pages):

Grille 625 x 75: $l_{0,2} = 8.0$ m
 $v_0 = 2.5$ m/s

Pressure loss and sound effect level:

The diagram "Pressure-Sound level":
 100% open damper

$$v_0 = 2.5 \text{ m/s} \quad v_k = 4.0 \text{ m/s}$$

$$p_t = 23 \text{ Pa}$$

$$L_{WA} = 44 \text{ dB(A)}$$

Free area: 0.034 m²
 Correction table 2: $- 2$

$$L_{WA} = 44 - 2 = 42 \text{ dB(A)}$$

The diagram "Pressure – Sound level": 50% open damper:

$$p_t = 42 \text{ Pa}$$

$$L_{WA} = 50 - 2 = 48 \text{ dB(A)}$$

Circular duct grille

RGS

Technical data - Supply air

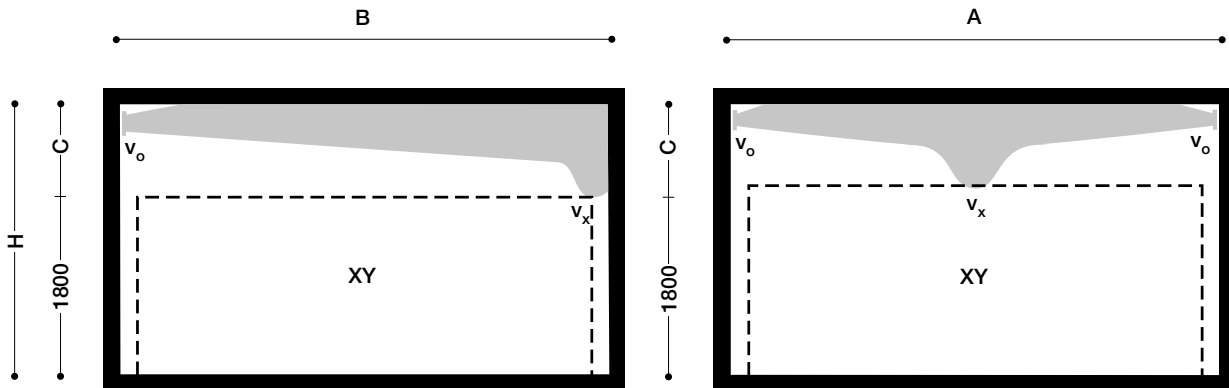

XY = occupied zone

Final velocities

The speed in occupied zone v_x :

$$v_x = \frac{l_{0,2}}{B + C} \times 0,2 \text{ m/s}$$

$$v_x = \frac{l_{0,2}}{\frac{A}{2} + C} \times 0,2 \text{ m/s}$$

Terminal velocity v_x at distance X:

$$v_x = \frac{l_{0,2} \times 0,2}{X}$$

Other terminal velocities v_x :

The distance to the point where the speed has decreased to

v_x is: $X = K \times l_{0,2}$

Table 4:

v_x m/s	0,15	0,2	0,25	0,3	0,35	0,4
K	1,33	1,0	0,8	0,67	0,57	0,5

Final velocities

Room: Width: W = 7 m, Height: 2.7 m

$$C = 2.7 - 1.8 = 0.9 \text{ m}$$

Grille: 825 x 75

Volume flow: 400 m³/h

Throw according to the diagram on the next page:

$$l_{0,2} = 9.0 \text{ m}$$

The speed in the occupied zone:

$$v_x = \frac{l_{0,2}}{B + C} \times 0,2 = \frac{9,0}{7,9} \times 0,2 = 0,23 \text{ m/s}$$

The speed 4 m from the grille is:

$$v_x = \frac{l_{0,2} \times 0,2}{B + C} = \frac{9 \times 0,2}{4} = 0,45 \text{ m/s}$$

The distance to the point where the speed has decreased to 0,3 m/s is:

$$0.67 \times l_{0,2} = 0.67 \times 9 = \underline{6.0 \text{ m}}$$

Circular duct grille

RGS

Technical data - Supply and extract air

Effective speed v_0 - Throw $l_{0,2}$

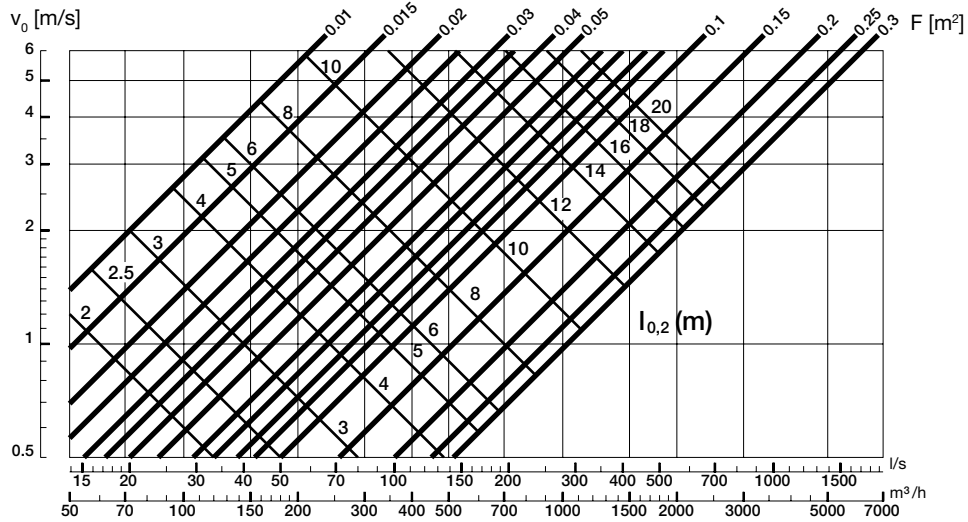

Sample calculation 3

Grille 1025 x 75

Volume flow: 500 m³/h

Supply air speed: $v_0 = 2.7$ m/s

Throw: $l_{0,2} = 10.0$ m

With 90° dispersal: (See table 1, previous page)

$$v_0 = 1.2 \times 2.7 = 3.2 \text{ m/s}$$

$$l_{0,2} = 0.5 \times 10.0 = 5.0 \text{ m}$$

Circular duct grille

RGS

Technical data- - Supply and extract air

Pressure - Sound level

RGS with accessories 4, 6 and 7

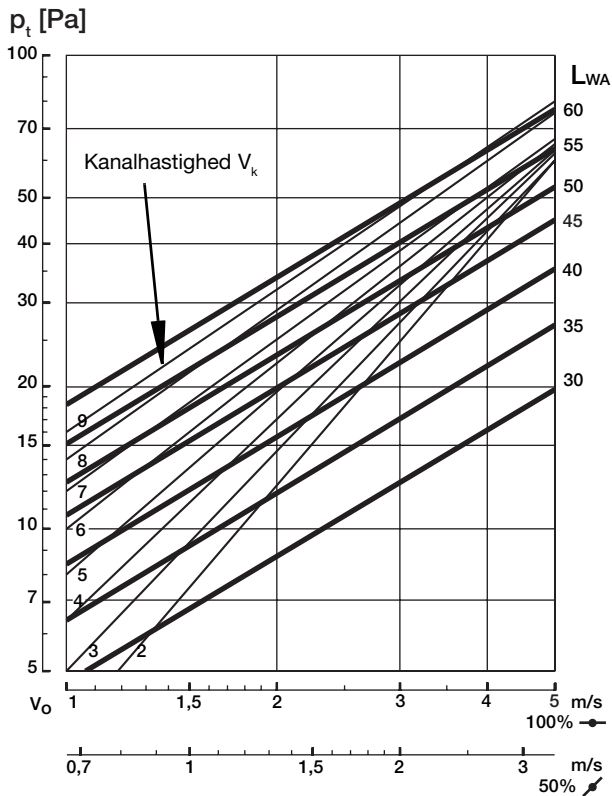

Correction

Correction for RGS with accessories 2 and 3.

Table 5:

Total pressure p_t	x 0,75	Pa
Sound power level L_{WA}	-3	dB(A)

Sample calculation 4

RGS-6 625 x 75 Area: 0.034 m²

Volume flow: 250 m³/h

Supply air speed: $v_o = 2.0$ m/s

Duct speed: $v_k = 4$ m/s

100% open damper:

$$p_t = 17 \text{ Pa}$$

$$L_{WA} = 42 \text{ dB}$$

Correction for free area according to table 2 page 4:

$$0.03 \text{ m}^2: -2 \text{ dB}$$

$$L_{WA} = 42 - 2 = 40 \text{ dB}$$

50% open damper:

$$p_t = 30 \text{ Pa}$$

$$L_{WA} = 47 - 2 = 45 \text{ dB}$$

Dimensioning tables for RGS

The following pages contain dimensioning tables for RGS with accessories 4, 6 and 7.

Correction for RGS with accessories 2 and 3 - see table 5.

Explanation for dimensioning tables

- Volume of air m³/h
- Throw m
- Duct speed m/s
- 100% open damper
- 50% open damper
- Volume of air l/s
- Pressure loss Pa
- Sound level dB
- Pressure loss Pa
- Sound level dB

1	q: 1200 m ³ /h - 333 l/s			6		
2	l _{0,2} : 11,0 m					
3	v _k -m/s	3	6	9		
4	100%	p _t	10	16	24	7
		L _w	40	51	62	8
5	50%	p _t	17	25	35	9
		L _w	46	56	64	10

Circular duct grille

RGS

Technical data-Supply and extract air

Dimensioning table with accessories 4, 6 and 7

B dimension: 75 mm

325x75 0.017 m ² Min.duct measure Ø160	q: 75 m ³ /h - 21 l/s l _{0.2} : 2.0 m			q: 100 m ³ /h - 28 l/s l _{0.2} : 3.0 m			q: 150 m ³ /h - 42 l/s l _{0.2} : 4.5 m			q: 200 m ³ /h - 56 l/s l _{0.2} : 7.0 m			q: 250 m ³ /h - 69 l/s l _{0.2} : 9.0 m		
	v _k -m/s			v _k -m/s			v _k -m/s			v _k -m/s			v _k -m/s		
	100%			100%			100%			100%			100%		
	50%			50%			50%			50%			50%		
425x75 0.023 m ² Min.duct measure Ø160	q: 100 m ³ /h - 28 l/s l _{0.2} : 2.5 m			q: 150 m ³ /h - 42 l/s l _{0.2} : 4.5 m			q: 200 m ³ /h - 56 l/s l _{0.2} : 5.5 m			q: 250 m ³ /h - 69 l/s l _{0.2} : 7.0 m			q: 300 m ³ /h - 83 l/s l _{0.2} : 9.0 m		
	v _k -m/s			v _k -m/s			v _k -m/s			v _k -m/s			v _k -m/s		
	100%			100%			100%			100%			100%		
	50%			50%			50%			50%			50%		
525x75 0.028 m ² Min.duct measure Ø160	q: 150 m ³ /h - 42 l/s l _{0.2} : 3.9 m			q: 200 m ³ /h - 56 l/s l _{0.2} : 5.5 m			q: 250 m ³ /h - 69 l/s l _{0.2} : 7.5 m			q: 300 m ³ /h - 83 l/s l _{0.2} : 9.0 m			q: 350 m ³ /h - 97 l/s l _{0.2} : 10.0 m		
	v _k -m/s			v _k -m/s			v _k -m/s			v _k -m/s			v _k -m/s		
	100%			100%			100%			100%			100%		
	50%			50%			50%			50%			50%		
625x75 0.034 m ² Min.duct measure Ø160	q: 200 m ³ /h - 56 l/s l _{0.2} : 5.0 m			q: 250 m ³ /h - 69 l/s l _{0.2} : 6.5 m			q: 300 m ³ /h - 83 l/s l _{0.2} : 8.5 m			q: 350 m ³ /h - 97 l/s l _{0.2} : 9.5 m			q: 400 m ³ /h - 111 l/s l _{0.2} : 10.5 m		
	v _k -m/s			v _k -m/s			v _k -m/s			v _k -m/s			v _k -m/s		
	100%			100%			100%			100%			100%		
	50%			50%			50%			50%			50%		
825x75 0.045 m ² Min.duct measure Ø160	q: 250 m ³ /h - 69 l/s l _{0.2} : 5.2 m			q: 300 m ³ /h - 83 l/s l _{0.2} : 7.0 m			q: 400 m ³ /h - 111 l/s l _{0.2} : 9.0 m			q: 500 m ³ /h - 139 l/s l _{0.2} : 10.5 m			q: 600 m ³ /h - 167 l/s l _{0.2} : 12.0 m		
	v _k -m/s			v _k -m/s			v _k -m/s			v _k -m/s			v _k -m/s		
	100%			100%			100%			100%			100%		
	50%			50%			50%			50%			50%		
1025x75 0.056 m ² Min.duct measure Ø200	q: 300 m ³ /h - 83 l/s l _{0.2} : 6.0 m			q: 400 m ³ /h - 111 l/s l _{0.2} : 8.5 m			q: 500 m ³ /h - 139 l/s l _{0.2} : 10.0 m			q: 600 m ³ /h - 167 l/s l _{0.2} : 11.5 m			q: 700 m ³ /h - 194 l/s l _{0.2} : 13.0 m		
	v _k -m/s			v _k -m/s			v _k -m/s			v _k -m/s			v _k -m/s		
	100%			100%			100%			100%			100%		
	50%			50%			50%			50%			50%		
1225x75 0.068 m ² Min.duct measure Ø200	q: 400 m ³ /h - 111 l/s l _{0.2} : 7.0 m			q: 500 m ³ /h - 139 l/s l _{0.2} : 9.0 m			q: 600 m ³ /h - 167 l/s l _{0.2} : 10.5 m			q: 700 m ³ /h - 194 l/s l _{0.2} : 11.5 m			q: 800 m ³ /h - 222 l/s l _{0.2} : 13.0 m		
	v _k -m/s			v _k -m/s			v _k -m/s			v _k -m/s			v _k -m/s		
	100%			100%			100%			100%			100%		
	50%			50%			50%			50%			50%		

Circular duct grille

RGS

Technical data-Supply and extract air

Dimensioning table with accessories 4, 6 and 7

B dimension: 125 mm

325x125 0.028 m ² Min.duct measure Ø250	q: 150 m ³ /h - 42 l/s l _{0.2} : 3.9 m				q: 200 m ³ /h - 56 l/s l _{0.2} : 5.5 m				q: 250 m ³ /h - 69 l/s l _{0.2} : 7.5 m				q: 300 m ³ /h - 83 l/s l _{0.2} : 9.0 m				q: 350 m ³ /h - 97 l/s l _{0.2} : 10.0 m													
	v _k -m/s				v _k -m/s				v _k -m/s				v _k -m/s				v _k -m/s													
	100%		p _t	11	16	25	100%		p _t	14	22	32	100%		p _t	21	28	38	100%		p _t	25	35	48	100%		p _t	35	43	55
	50%		L _W	33	44	55	50%		L _W	36	46	56	50%		L _W	39	48	57	50%		L _W	41	50	57	50%		L _W	45	52	58
425x125 0.037 m ² Min.duct measure Ø250	q: 200 m ³ /h - 56 l/s l _{0.2} : 4.5 m				q: 250 m ³ /h - 69 l/s l _{0.2} : 6.0 m				q: 300 m ³ /h - 83 l/s l _{0.2} : 7.5 m				q: 350 m ³ /h - 97 l/s l _{0.2} : 9.0 m				q: 400 m ³ /h - 111 l/s l _{0.2} : 10.0 m													
	v _k -m/s				v _k -m/s				v _k -m/s				v _k -m/s				v _k -m/s													
	100%		p _t	10	16	24	100%		p _t	12	20	28	100%		p _t	19	26	36	100%		p _t	22	29	39	100%		p _t	27	35	48
	50%		L _W	34	45	56	50%		L _W	36	46	55	50%		L _W	40	49	57	50%		L _W	40	50	59	50%		L _W	43	51	58
525x125 0.047 m ² Min.duct measure Ø250	q: 250 m ³ /h - 69 l/s l _{0.2} : 5.2 m				q: 300 m ³ /h - 83 l/s l _{0.2} : 7.0 m				q: 400 m ³ /h - 111 l/s l _{0.2} : 9.0 m				q: 500 m ³ /h - 139 l/s l _{0.2} : 10.5 m				q: 600 m ³ /h - 167 l/s l _{0.2} : 12.0 m													
	v _k -m/s				v _k -m/s				v _k -m/s				v _k -m/s				v _k -m/s													
	100%		p _t	10	16	24	100%		p _t	12	20	29	100%		p _t	21	28	38	100%		p _t	27	35	48	100%		p _t	37	46	57
	50%		L _W	35	46	57	50%		L _W	37	47	56	50%		L _W	41	50	59	50%		L _W	44	52	59	50%		L _W	48	55	60
625x125 0.056 m ² Min.duct measure Ø250	q: 300 m ³ /h - 83 l/s l _{0.2} : 6.0 m				q: 400 m ³ /h - 111 l/s l _{0.2} : 8.5 m				q: 500 m ³ /h - 139 l/s l _{0.2} : 10.0 m				q: 600 m ³ /h - 167 l/s l _{0.2} : 11.5 m				q: 700 m ³ /h - 194 l/s l _{0.2} : 13.0 m													
	v _k -m/s				v _k -m/s				v _k -m/s				v _k -m/s				v _k -m/s													
	100%		p _t	10	16	24	100%		p _t	14	22	32	100%		p _t	21	28	38	100%		p _t	27	35	48	100%		p _t	35	43	55
	50%		L _W	36	47	58	50%		L _W	39	49	59	50%		L _W	42	51	60	50%		L _W	45	53	60	50%		L _W	48	55	61
825x125 0.074 m ² Min.duct measure Ø250	q: 400 m ³ /h - 111 l/s l _{0.2} : 7.5 m				q: 500 m ³ /h - 139 l/s l _{0.2} : 9.0 m				q: 600 m ³ /h - 167 l/s l _{0.2} : 11.0 m				q: 700 m ³ /h - 194 l/s l _{0.2} : 11.5 m				q: 800 m ³ /h - 222 l/s l _{0.2} : 13.0 m													
	v _k -m/s				v _k -m/s				v _k -m/s				v _k -m/s				v _k -m/s													
	100%		p _t	10	16	24	100%		p _t	12	20	28	100%		p _t	19	26	36	100%		p _t	22	29	39	100%		p _t	27	35	48
	50%		L _W	36	47	58	50%		L _W	39	49	58	50%		L _W	43	52	60	50%		L _W	43	53	62	50%		L _W	46	54	62
1025x125 0.093 m ² Min.duct measure Ø250	q: 500 m ³ /h - 139 l/s l _{0.2} : 8.0 m				q: 600 m ³ /h - 167 l/s l _{0.2} : 9.5 m				q: 700 m ³ /h - 194 l/s l _{0.2} : 10.5 m				q: 800 m ³ /h - 222 l/s l _{0.2} : 12.0 m				q: 1000 m ³ /h - 278 l/s l _{0.2} : 14.0 m													
	v _k -m/s				v _k -m/s				v _k -m/s				v _k -m/s				v _k -m/s													
	100%		p _t	10	16	24	100%		p _t	12	20	29	100%		p _t	16	23	33	100%		p _t	20	28	38	100%		p _t	27	35	48
	50%		L _W	37	48	59	50%		L _W	40	50	59	50%		L _W	40	52	61	50%		L _W	44	53	62	50%		L _W	47	55	63
1225x125 0.112 m ² Min.duct measure Ø250	q: 600 m ³ /h - 167 l/s l _{0.2} : 9.0 m				q: 700 m ³ /h - 194 l/s l _{0.2} : 10.0 m				q: 800 m ³ /h - 222 l/s l _{0.2} : 11.5 m				q: 1000 m ³ /h - 278 l/s l _{0.2} : 13.0 m				q: 1200 m ³ /h - 333 l/s l _{0.2} : 15.0 m													
	v _k -m/s				v _k -m/s				v _k -m/s				v _k -m/s				v _k -m/s													
	100%		p _t	10	16	24	100%		p _t	12	19	27	100%		p _t	14	22	32	100%		p _t	21	28	38	100%		p _t	27	35	48
	50%		L _W	38	49	60	50%		L _W	41	51	62	50%		L _W	42	52	62	50%		L _W	45	54	63	50%		L _W	48	56	64

Circular duct grille

RGS

Technical data-Supply and extract air

Dimensioning table with accessories 4, 6 and 7

B dimension: 150 mm

325x150 0.034 m ² Min.duct measure Ø315	q: 200 m ³ /h - 56 l/s l _{0,2} : 5.0 m			q: 250 m ³ /h - 69 l/s l _{0,2} : 6.5 m			q: 300 m ³ /h - 83 l/s l _{0,2} : 8.5 m			q: 350 m ³ /h - 97 l/s l _{0,2} : 9.5 m			q: 400 m ³ /h - 111 l/s l _{0,2} : 10.5 m		
	v _k -m/s			v _k -m/s			v _k -m/s			v _k -m/s			v _k -m/s		
	100%	p _t	11 16 25	100%	p _t	14 22 32	100%	p _t	21 28 38	100%	p _t	25 35 48	100%	p _t	30 38 52
		L _W	34 45 54		L _W	37 47 57		L _W	40 49 58		L _W	42 51 58		L _W	44 52 59
50%	p _t	20 30 40	50%	p _t	28 37 47	50%	p _t	38 47 60	50%	p _t	48 57 67	50%	p _t	60 65 81	
	L _W	40 48 57		L _W	43 51 58		L _W	47 53 59		L _W	50 54 60		L _W	52 54 61	
425x150 0.045 m ² Min.duct measure Ø315	q: 250 m ³ /h - 69 l/s l _{0,2} : 5.2 m			q: 300 m ³ /h - 83 l/s l _{0,2} : 7.0 m			q: 400 m ³ /h - 111 l/s l _{0,2} : 9.0 m			q: 500 m ³ /h - 139 l/s l _{0,2} : 10.5 m			q: 600 m ³ /h - 167 l/s l _{0,2} : 12.0 m		
	v _k -m/s			v _k -m/s			v _k -m/s			v _k -m/s			v _k -m/s		
	100%	p _t	10 16 24	100%	p _t	12 20 29	100%	p _t	21 28 38	100%	p _t	27 35 48	100%	p _t	37 46 57
		L _W	35 46 57		L _W	37 47 56		L _W	41 50 59		L _W	44 52 59		L _W	48 55 60
50%	p _t	17 25 35	50%	p _t	26 31 43	50%	p _t	38 47 60	50%	p _t	51 56 74	50%	p _t	72 82 93	
	L _W	40 50 58		L _W	43 52 59		L _W	48 54 60		L _W	52 54 61		L _W	57 60 63	
525x150 0.056 m ² Min.duct measure Ø315	q: 300 m ³ /h - 83 l/s l _{0,2} : 6.0 m			q: 400 m ³ /h - 111 l/s l _{0,2} : 8.5 m			q: 500 m ³ /h - 139 l/s l _{0,2} : 10.0 m			q: 600 m ³ /h - 167 l/s l _{0,2} : 11.5 m			q: 700 m ³ /h - 194 l/s l _{0,2} : 13.0 m		
	v _k -m/s			v _k -m/s			v _k -m/s			v _k -m/s			v _k -m/s		
	100%	p _t	10 16 24	100%	p _t	14 22 32	100%	p _t	21 28 38	100%	p _t	27 35 48	100%	p _t	35 43 55
		L _W	36 47 58		L _W	39 49 59		L _W	42 51 60		L _W	45 53 60		L _W	48 55 61
50%	p _t	17 25 35	50%	p _t	28 37 47	50%	p _t	38 47 60	50%	p _t	51 56 74	50%	p _t	69 78 89	
	L _W	41 51 59		L _W	45 53 60		L _W	49 55 61		L _W	53 55 61		L _W	57 61 64	
625x150 0.068 m ² Min.duct measure Ø315	q: 400 m ³ /h - 111 l/s l _{0,2} : 7.0 m			q: 500 m ³ /h - 139 l/s l _{0,2} : 9.0 m			q: 600 m ³ /h - 167 l/s l _{0,2} : 10.5 m			q: 700 m ³ /h - 194 l/s l _{0,2} : 11.5 m			q: 800 m ³ /h - 222 l/s l _{0,2} : 13.0 m		
	v _k -m/s			v _k -m/s			v _k -m/s			v _k -m/s			v _k -m/s		
	100%	p _t	11 17 26	100%	p _t	14 22 32	100%	p _t	21 28 38	100%	p _t	25 35 48	100%	p _t	30 38 52
		L _W	37 48 59		L _W	40 50 60		L _W	43 52 61		L _W	45 54 61		L _W	47 55 62
50%	p _t	20 28 38	50%	p _t	28 37 47	50%	p _t	38 47 60	50%	p _t	48 57 68	50%	p _t	60 65 81	
	L _W	43 51 60		L _W	46 54 61		L _W	50 52 62		L _W	53 57 63		L _W	55 57 64	
825x150 0.093 m ² Min.duct measure Ø315	q: 500 m ³ /h - 139 l/s l _{0,2} : 8.0 m			q: 600 m ³ /h - 167 l/s l _{0,2} : 9.5 m			q: 700 m ³ /h - 194 l/s l _{0,2} : 10.5 m			q: 800 m ³ /h - 222 l/s l _{0,2} : 12.0 m			q: 1000 m ³ /h - 278 l/s l _{0,2} : 14.0 m		
	v _k -m/s			v _k -m/s			v _k -m/s			v _k -m/s			v _k -m/s		
	100%	p _t	10 16 24	100%	p _t	12 20 29	100%	p _t	16 23 33	100%	p _t	20 28 38	100%	p _t	27 35 48
		L _W	37 48 59		L _W	40 50 59		L _W	40 52 61		L _W	44 53 62		L _W	47 55 63
50%	p _t	17 25 35	50%	p _t	26 31 43	50%	p _t	29 39 50	50%	p _t	38 45 60	50%	p _t	51 56 74	
	L _W	43 53 61		L _W	46 55 62		L _W	48 56 63		L _W	51 57 63		L _W	55 57 63	
1025x150 0.112 m ² Min.duct measure Ø315	q: 600 m ³ /h - 167 l/s l _{0,2} : 9.0 m			q: 700 m ³ /h - 194 l/s l _{0,2} : 10.0 m			q: 800 m ³ /h - 222 l/s l _{0,2} : 11.0 m			q: 1000 m ³ /h - 278 l/s l _{0,2} : 13.0 m			q: 1200 m ³ /h - 333 l/s l _{0,2} : 15.0 m		
	v _k -m/s			v _k -m/s			v _k -m/s			v _k -m/s			v _k -m/s		
	100%	p _t	10 16 24	100%	p _t	12 19 27	100%	p _t	14 22 32	100%	p _t	21 28 38	100%	p _t	27 35 48
		L _W	38 49 60		L _W	41 51 62		L _W	42 52 62		L _W	45 54 63		L _W	48 56 64
50%	p _t	17 25 35	50%	p _t	21 30 41	50%	p _t	28 37 47	50%	p _t	38 47 60	50%	p _t	51 56 74	
	L _W	44 54 62		L _W	46 55 63		L _W	48 56 63		L _W	52 58 64		L _W	56 58 64	
1225x150 0.136 m ² Min.duct measure Ø315	q: 700 m ³ /h - 222 l/s l _{0,2} : 8.5 m			q: 800 m ³ /h - 278 l/s l _{0,2} : 10.0 m			q: 1000 m ³ /h - 333 l/s l _{0,2} : 11.5 m			q: 1200 m ³ /h - 389 l/s l _{0,2} : 13.0 m			q: 1400 m ³ /h - 444 l/s l _{0,2} : 15.0 m		
	v _k -m/s			v _k -m/s			v _k -m/s			v _k -m/s			v _k -m/s		
	100%	p _t	8 15 22	100%	p _t	11 16 25	100%	p _t	14 22 32	100%	p _t	21 28 38	100%	p _t	25 35 48
		L _W	39 49 61		L _W	39 50 61		L _W	42 52 62		L _W	45 54 63		L _W	47 56 63
50%	p _t	16 23 33	50%	p _t	20 28 38	50%	p _t	28 37 47	50%	p _t	38 47 60	50%	p _t	48 57 67	
	L _W	41 53 62		L _W	45 53 62		L _W	48 56 63		L _W	52 58 64		L _W	55 59 65	

Circular duct grille

RGS

Technical data-Supply and extract air

Dimensioning table with accessories 4, 6 and 7

B dimension: 225 mm

325x225 0.056 m ² Min.duct measure Ø500	q: 300 m ³ /h - 83 l/s l _{0.2} : 6.0 m				q: 400 m ³ /h - 111 l/s l _{0.2} : 8.5 m				q: 500 m ³ /h - 139 l/s l _{0.2} : 10.0 m				q: 600 m ³ /h - 167 l/s l _{0.2} : 11.5 m				q: 700 m ³ /h - 194 l/s l _{0.2} : 13.0 m													
	v _k -m/s				v _k -m/s				v _k -m/s				v _k -m/s				v _k -m/s													
	100%		p _t	10	16	24	100%		p _t	14	22	32	100%		p _t	21	28	38	100%		p _t	27	35	48	100%		p _t	35	43	55
			L _W	36	47	58			L _W	39	49	59			L _W	42	51	60			L _W	45	53	60			L _W	48	55	61
50%		p _t	17	25	35	50%		p _t	28	37	47	50%		p _t	38	47	60	50%		p _t	51	56	74	50%		p _t	69	78	89	
		L _W	41	51	59			L _W	45	53	60			L _W	49	55	61			L _W	53	55	61			L _W	57	61	64	
425x225 0.074 m ² Min.duct measure Ø500	q: 400 m ³ /h - 111 l/s l _{0.2} : 7.5 m				q: 500 m ³ /h - 139 l/s l _{0.2} : 9.0 m				q: 600 m ³ /h - 167 l/s l _{0.2} : 11.0 m				q: 700 m ³ /h - 194 l/s l _{0.2} : 11.5 m				q: 800 m ³ /h - 222 l/s l _{0.2} : 13.0 m													
	v _k -m/s				v _k -m/s				v _k -m/s				v _k -m/s				v _k -m/s													
	100%		p _t	10	16	24	100%		p _t	12	20	28	100%		p _t	19	26	36	100%		p _t	22	29	39	100%		p _t	27	35	48
			L _W	36	47	58			L _W	39	49	58			L _W	43	52	60			L _W	43	53	62			L _W	46	54	62
50%		p _t	17	25	35	50%		p _t	26	35	46	50%		p _t	34	44	56	50%		p _t	43	52	62	50%		p _t	51	56	74	
		L _W	42	52	60			L _W	45	52	60			L _W	49	55	61			L _W	50	56	62			L _W	54	56	62	
525x225 0.093 m ² Min.duct measure Ø500	q: 500 m ³ /h - 139 l/s l _{0.2} : 8.0 m				q: 600 m ³ /h - 167 l/s l _{0.2} : 9.5 m				q: 700 m ³ /h - 194 l/s l _{0.2} : 10.5 m				q: 800 m ³ /h - 222 l/s l _{0.2} : 12.0 m				q: 1000 m ³ /h - 278 l/s l _{0.2} : 14.0 m													
	v _k -m/s				v _k -m/s				v _k -m/s				v _k -m/s				v _k -m/s													
	100%		p _t	10	16	24	100%		p _t	12	20	29	100%		p _t	16	23	33	100%		p _t	20	28	38	100%		p _t	27	35	48
			L _W	37	48	59			L _W	40	50	59			L _W	40	52	61			L _W	44	53	62			L _W	47	55	63
50%		p _t	17	25	35	50%		p _t	26	31	43	50%		p _t	29	39	50	50%		p _t	38	45	60	50%		p _t	51	56	74	
		L _W	43	53	61			L _W	46	55	62			L _W	48	56	63			L _W	51	57	63			L _W	55	57	63	
625x225 0.112 m ² Min.duct measure Ø250	q: 600 m ³ /h - 167 l/s l _{0.2} : 9.0 m				q: 700 m ³ /h - 194 l/s l _{0.2} : 10.0 m				q: 800 m ³ /h - 222 l/s l _{0.2} : 11.0 m				q: 1000 m ³ /h - 278 l/s l _{0.2} : 13.0 m				q: 1200 m ³ /h - 333 l/s l _{0.2} : 15.0 m													
	v _k -m/s				v _k -m/s				v _k -m/s				v _k -m/s				v _k -m/s													
	100%		p _t	10	16	24	100%		p _t	12	19	27	100%		p _t	14	22	32	100%		p _t	21	28	38	100%		p _t	27	35	48
			L _W	38	49	60			L _W	41	51	62			L _W	42	52	62			L _W	45	54	63			L _W	48	56	64
50%		p _t	17	25	35	50%		p _t	21	30	41	50%		p _t	28	37	47	50%		p _t	38	47	60	50%		p _t	51	56	74	
		L _W	44	54	62			L _W	46	55	63			L _W	48	56	63			L _W	52	58	64			L _W	56	58	64	
825x225 0.148 m ² Min.duct measure Ø500	q: 800 m ³ /h - 222 l/s l _{0.2} : 9.5 m				q: 1000 m ³ /h - 278 l/s l _{0.2} : 11.5 m				q: 1200 m ³ /h - 333 l/s l _{0.2} : 13.0 m				q: 1400 m ³ /h - 389 l/s l _{0.2} : 15.0 m				q: 1600 m ³ /h - 444 l/s l _{0.2} : 17.0 m													
	v _k -m/s				v _k -m/s				v _k -m/s				v _k -m/s				v _k -m/s													
	100%		p _t	10	16	24	100%		p _t	12	20	28	100%		p _t	19	26	36	100%		p _t	22	30	40	100%		p _t	27	35	48
			L _W	39	50	61			L _W	42	52	61			L _W	46	55	63			L _W	46	56	64			L _W	49	57	65
50%		p _t	17	25	35	50%		p _t	27	35	45	50%		p _t	34	44	56	50%		p _t	43	52	62	50%		p _t	51	56	74	
		L _W	45	55	63			L _W	48	55	63			L _W	52	58	65			L _W	53	59	65			L _W	57	59	65	
1025x225 0.186 m ² Min.duct measure Ø500	q: 1000 m ³ /h - 278 l/s l _{0.2} : 11.0 m				q: 1200 m ³ /h - 333 l/s l _{0.2} : 12.0 m				q: 1400 m ³ /h - 389 l/s l _{0.2} : 13.5 m				q: 1600 m ³ /h - 444 l/s l _{0.2} : 15.0 m				q: 1800 m ³ /h - 500 l/s l _{0.2} : 17.0 m													
	v _k -m/s				v _k -m/s				v _k -m/s				v _k -m/s				v _k -m/s													
	100%		p _t	10	16	24	100%		p _t	12	20	30	100%		p _t	16	23	33	100%		p _t	20	27	37	100%		p _t	23	31	42
			L _W	40	51	62			L _W	43	53	62			L _W	43	55	64			L _W	47	56	65			L _W	48	57	66
50%		p _t	17	25	35	50%		p _t	26	31	43	50%		p _t	30	41	49	50%		p _t	38	45	60	50%		p _t	44	52	64	
		L _W	46	56	64			L _W	49	58	65			L _W	51	59	66			L _W	54	60	66			L _W	56	61	66	
1225x225 0.224 m ² Min.duct measure Ø500	q: 1200 m ³ /h - 333 l/s l _{0.2} : 11.0 m				q: 1400 m ³ /h - 389 l/s l _{0.2} : 12.0 m				q: 1600 m ³ /h - 444 l/s l _{0.2} : 14.0 m				q: 1800 m ³ /h - 500 l/s l _{0.2} : 15.5 m				q: 2000 m ³ /h - 556 l/s l _{0.2} : 17.0 m													
	v _k -m/s				v _k -m/s				v _k -m/s				v _k -m/s				v _k -m/s													
	100%		p _t	10	16	24	100%		p _t	12	19	27	100%		p _t	14	22	32	100%		p _t	18	25	35	100%		p _t	21	28	38
			L _W	40	51	62			L _W	43	53	64			L _W	44	54	64			L _W	47	56	64			L _W	47	56	65
50%		p _t	17	25	35	50%		p _t	21	30	41	50%		p _t	28	37	47	50%		p _t	34	44	56	50%		p _t	38	47	60	
		L _W	46	56	64			L _W	48	57	65			L _W	50	58	66			L _W	53	59	66			L _W	54	60	66	



Most of us spend the majority of our time indoors. Indoor climate is crucial to how we feel, how productive we are and if we stay healthy.

We at Lindab have therefore made it our most important objective to contribute to an indoor climate that improves people's lives. We do this by developing energy-efficient ventilation solutions and durable building products. We also aim to contribute to a better climate for our planet by working in a way that is sustainable for both people and the environment.

[Lindab](#) | For a better climate